

SINGER

BUTTONHOLER

THE SINGER MANUFACTURING CO.



Instructions For Using
SINGER BUTTONHOLER

NO. 160506

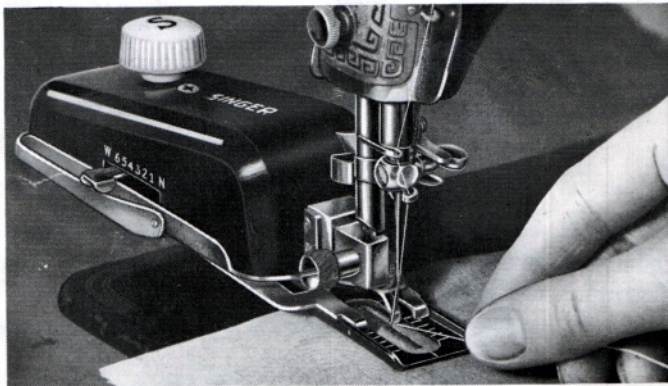

Form 20409
(9-51)

Printed in U. S. A.

**Instructions on the
Operation and Care of
SINGER* BUTTONHOLER
No. 160506**

This attachment is intended for use on SINGER* Lock Stitch Family Sewing Machines and produces neat and durable buttonholes in a great variety of fabrics without any special skill on the part of the operator. The buttonholes are produced in a fraction of the time required for hand work and they are firmer and more even than those made by hand.

*A Trade Mark of The Singer Manufacturing Co.

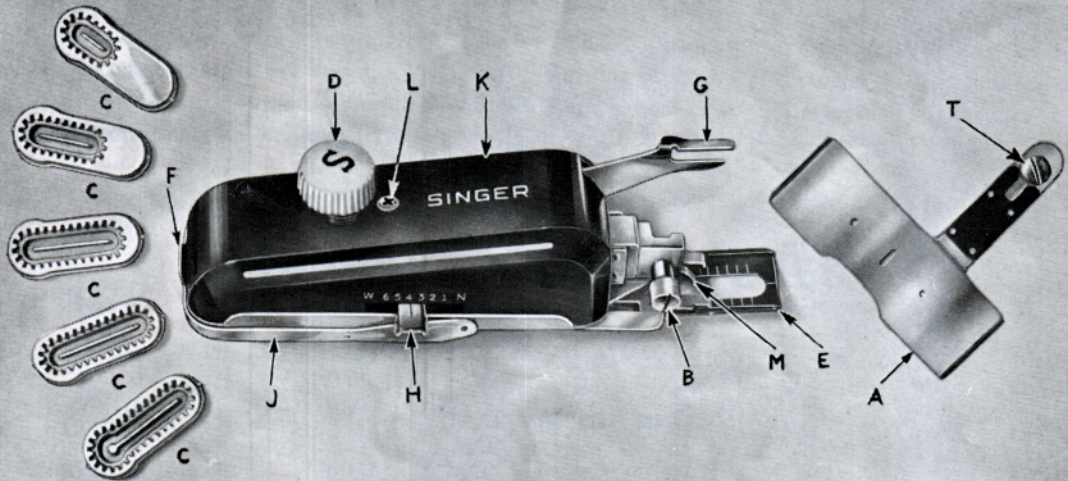

Refer to letters on illustrations to become familiar with the parts of the Buttonholer.

A—FEED COVER PLATE—Protects feed of machine.

B—SLOTTED CLAMPING SCREW—Fastens Attachment to presser bar.

C—TEMPLATES—Control size and shape of buttonholes.

D—ADJUSTING KNOB—Locates Cloth Clamp.

E—CLOTH CLAMP—Grips fabric firmly.

F—LOCK—Locks Template Retainer Plate in position.

G—FORK ARM—Straddles Needle Clamp to actuate attachment.

H—BIGHT ADJUSTER—Determines the width of side stitch.

J —TEMPLATE RETAINER PLATE—Retains Templates in place.

K—COVER—Encloses moving parts of attachment.

L—COVER SCREW—Holds Cover in position.

M—STRIPPER FOOT—Holds fabric firmly as stitches are taken.

T —FEED COVER PLATE SCREW—Fastens Feed Cover Plate to machine.

TO SELECT THE PROPER TEMPLATE FOR DESIRED BUTTONHOLES

A set of five Templates with which to make various size buttonholes is furnished with the attachment. The sizes cover buttonhole lengths $5/16''$, $5/8''$, $13/16''$ and $1-1/16''$ for straight buttonholes and a keyhole shaped Template for eyelet end buttonholes $1-1/16''$ for suits and coats. (The $1-1/16''$ Template for keyhole buttonholes is already in the attachment.) The length of cutting area of the buttonhole made by each Template is indicated by the measurement line (shown by arrow in Fig. 2) embossed on back of Template. The size of the buttonhole is marked at center of measurement line.

Fig. 2

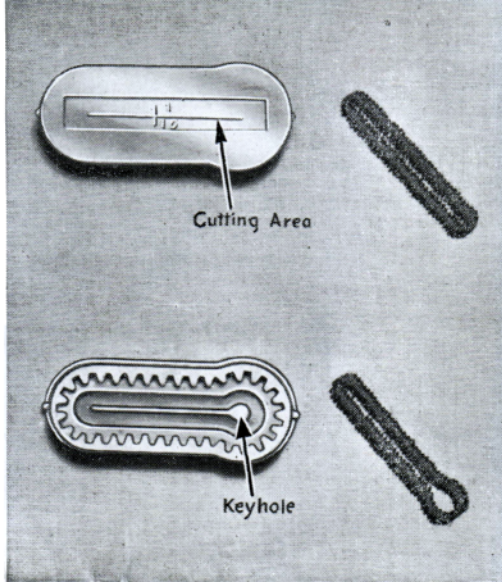

Additional Templates can be procured in sizes $15/16''$, $1/2''$, $3/8''$ for straight buttonholes and a keyhole shaped Template $5/8''$ long.

To determine the Template needed to make the correct size buttonhole for a flat button, place the button over this measurement line on the back of Template (C) as shown in Fig. 3.

• *Make a Sample Test Strip*

Using each Template and following instructions on (page 14) make a sample of each buttonhole on a strip of light colored material. Mark the length under each one and keep sample handy in your Buttonhole Attachment Box. Cut buttonholes to test ornamental buttons which are thick or irregularly shaped.

Fig. 3

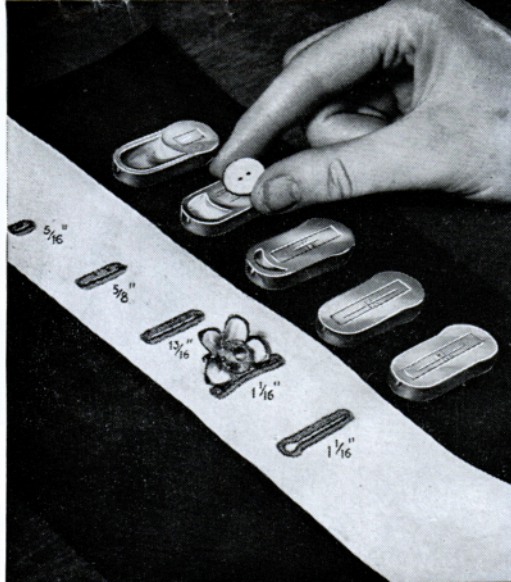

TO CHANGE TEMPLATE

● *Release Retainer Plate*

Turn the Cloth Clamp Adjusting Knob (D) clockwise, until Cloth Clamp (E) has just passed its extreme forward position toward you. Turn Attachment over as shown in (Fig. 4). Push the Retainer Plate (J) toward the back by pushing hinged edge forward with thumb of left hand as illustrated in (Fig. 4). Retainer Plate (J) will be released from Lock (F) at rear and can then be opened with the right hand.

Fig. 4

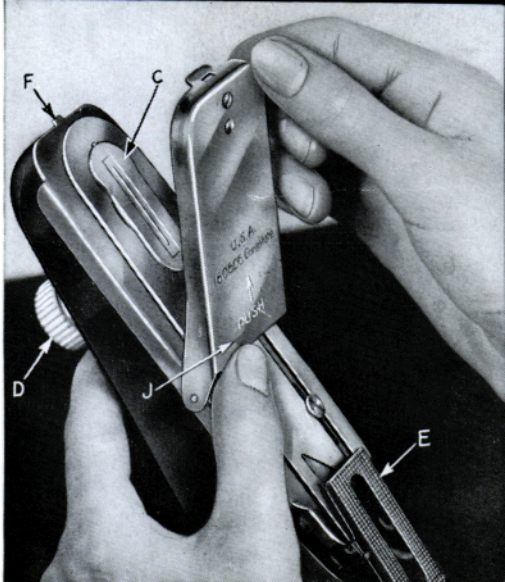

● **Changing Template**

To change Template (C), release Template Retainer Plate (J), as described on (page 8). Then grasp Template by inserting the thumb and finger in the curved slots "R" and lift out as shown in (Fig. 5). Having selected the Template (C) for size buttonhole desired, insert it in place of one just removed. In doing this, it may sometimes be necessary to slightly turn the Knob (D) until gears mesh and Template drops into place, then snap the Template Retainer Plate (J) back in position. The attachment is now ready to put on the presser bar of machine.

Fig. 5

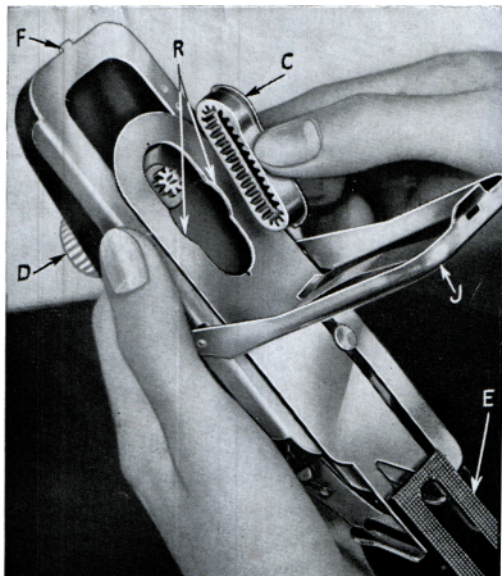

TO FASTEN FEED COVER PLATE TO MACHINE

1. Remove the presser foot and presser foot screw from the machine.
2. Place Feed Cover Plate (A) in position as shown in (Fig. 6).
3. Fasten Feed Cover Plate (A) to the bed of machine with the Feed Cover Plate Screw (T, Fig. 6), making sure that the needle passes through the center of the needle hole in the plate.

This Feed Cover Plate must be used with the Buttonhole Attachment at all times.

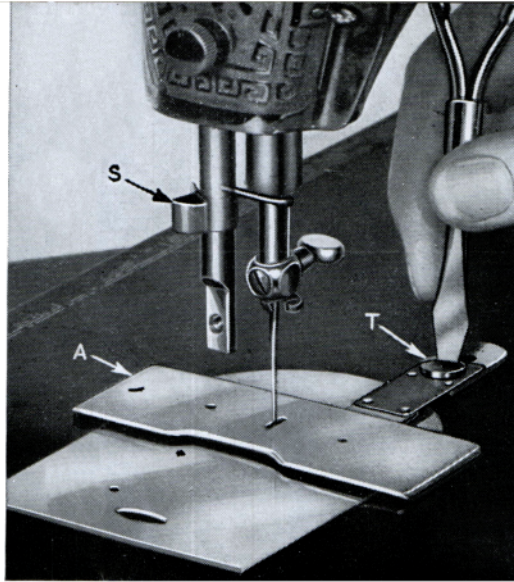

Fig. 6

TO FASTEN ATTACHMENT TO MACHINE

4. Guide the attachment into position from the rear of the machine so that the Fork Arm (G, Fig. 7) straddles the hub of the needle clamp, and securely fasten the attachment to the presser bar with the Slotted Clamping Screw (B, Fig. 7) using the large screwdriver. Turn the thread cutter (S, Fig. 6) to the left if it interferes with the attachment.

● *Threading*

Thread the machine as for ordinary sewing.

Fig. 7



ADJUSTING ATTACHMENT FOR WIDTH OF BIGHT

The width of stitch used for making a buttonhole is called the bight. Each of the six settings for width of bight provides a correct cutting space that eliminates ragged edges. To regulate the width of bight, press down on Bight Adjuster (H, Fig. 8) and move it to width of bight desired. Backward toward "W" for wider bight. Forward toward "N" for narrower bights. The different widths are numbered from 1 to 6 on left side of attachment.

Fig. 8

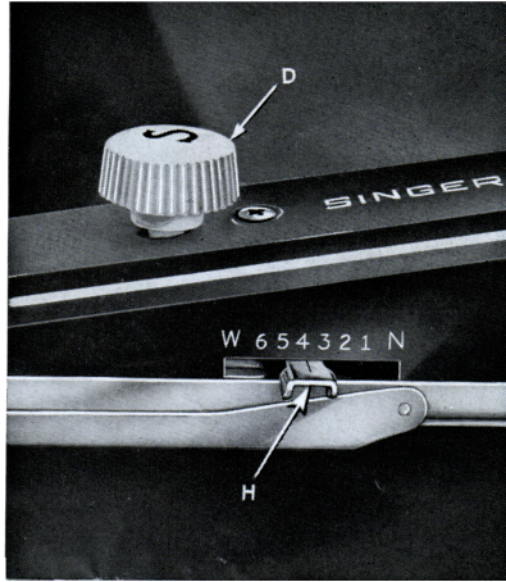

THE STRIPPER FOOT

A curved finger, called the Stripper Foot (M) presses firmly on the fabric before each plunge of the needle, and lifts, in advance of the movement of the Cloth Clamp (E) as each stitch is made, acting exactly as your finger would do in working fine hand-made buttonholes. This innovation prevents skipped or broken stitches, ensuring a perfectly balanced, smooth, strong buttonhole from start to finish, on *any kind or type of fabric*. It eliminates the necessity for using any kind of backing with the Buttonholer.

Fig. 9

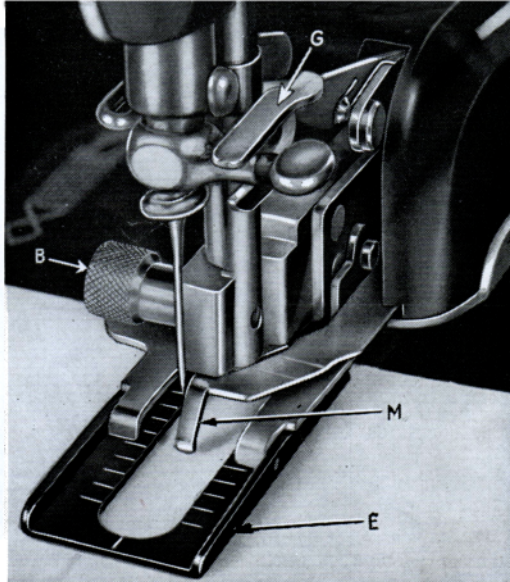

MAKING THE BUTTONHOLE

Baste, or pin mark the distance in from edge of material where rear end of buttonhole is to appear. Mark the distance between each buttonhole on garment with chalk, or a basting line, (See Fig. 10).

Turn Adjusting Knob (D) clockwise, moving Cloth Clamp (E) until it is all the way forward toward you, and needle appears at center line on rear of Cloth Clamp.

Place material under Cloth Clamp (E) positioning buttonhole marking in center of Cloth Clamp with needle directly above the outer end of marking; but not in cloth. (See Fig. 10).

Fig. 10

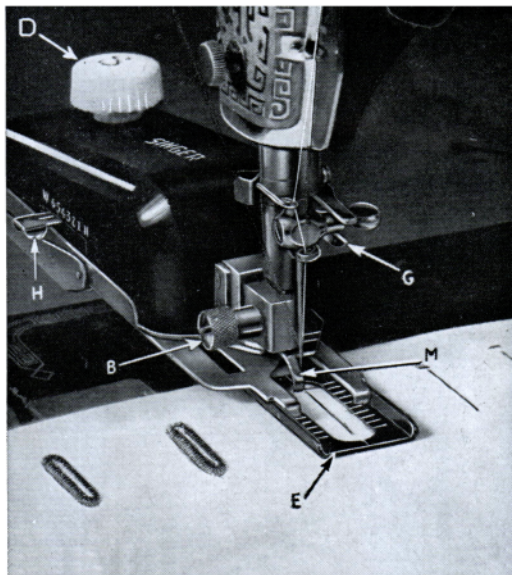

Lower presser bar so that cloth is held smoothly under Cloth Clamp (E). The pressure on the presser bar should be just sufficient to hold cloth firmly.

Turn Adjusting Knob (D, Fig. 10) clockwise again, moving Cloth Clamp (E) back away from you. Stop when Cloth Clamp has just passed needle at center front and is in a position to travel up left half of buttonhole, (which is the starting point). Hold needle thread and take a stitch drawing up the bobbin thread to the right side. Both bobbin and needle threads can be held so that stitches will cover them allowing them to act as a filler for extra strength around entire buttonhole, or they can be clipped off after several stitches have fastened them.

Fig. 11

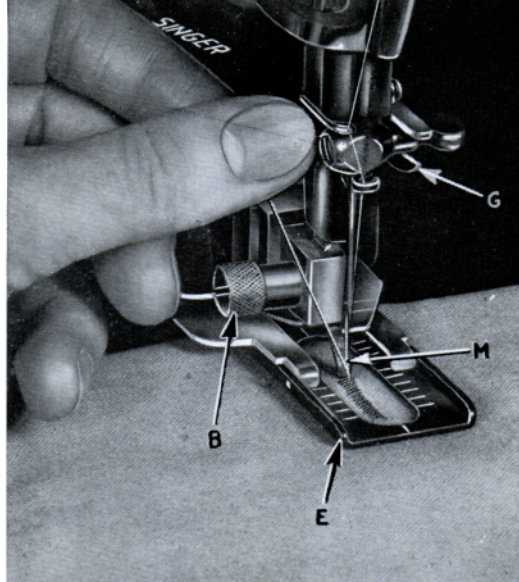

To encircle the entire buttonhole, hold these threads with the left hand, back of the needle and in front of Stripper Foot (M), holding the threads high as the stitches are formed over them. As the keyhole or opposite end of buttonhole is reached, transfer the threads to the right hand and proceed with threads held in front of the needle to the beginning of buttonhole.

Take work from machine. Clip filler threads and draw stitching thread to the wrong side and fasten.

If a raised effect is desired in buttonhole, heavier embroidery floss DMC No. 3 or darning cotton can be used as a filler. This filler thread can be fastened by the first stitches and should be held by hand in the same manner as needle and bobbin thread.

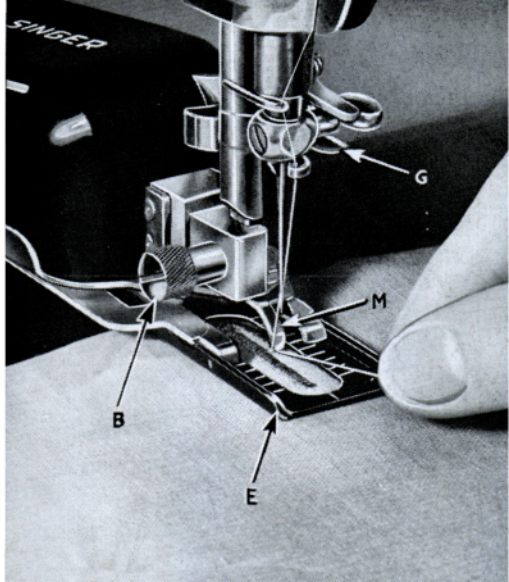

Fig. 12

BUTTONHOLES THAT RESEMBLE HAND WORK

A buttonhole that closely resembles hand work, so smart on tailored suits and coats, is made by putting a narrow stitch buttonhole on top of a wide stitch buttonhole.

First make buttonhole with Bight Adjuster (H) set wide. Stitch around twice for extra raised effect. Then without removing garment, change only the Bight Adjuster (H) to narrow, stitch around the buttonhole again. Thread ends may be guided under stitching as a filler, or clipped off as when making regular buttonholes.

A novel effect is produced by changing color of top thread for each stitch width.

Fig. 13

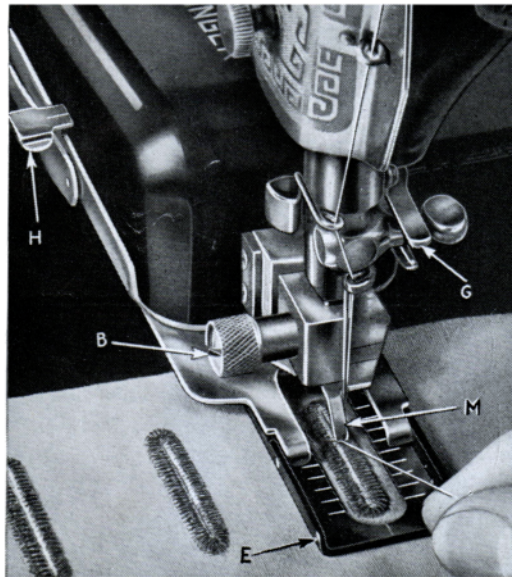

WORKING BUTTONHOLES IN HEAVY FABRIC

Perfect buttonholes can be made in all types of material. However, loosely woven materials which stretch easily such as jersey, or many of the basket weaves, should have an interlining of a firm fabric. An interlining will hold material firmly so that a neat buttonhole is made. This added firmness also keeps buttonholes in shape. Use cambric or taffeta between woolen or rayons; organdy or lawn between lighter weight and sheer material.

Fig. 14

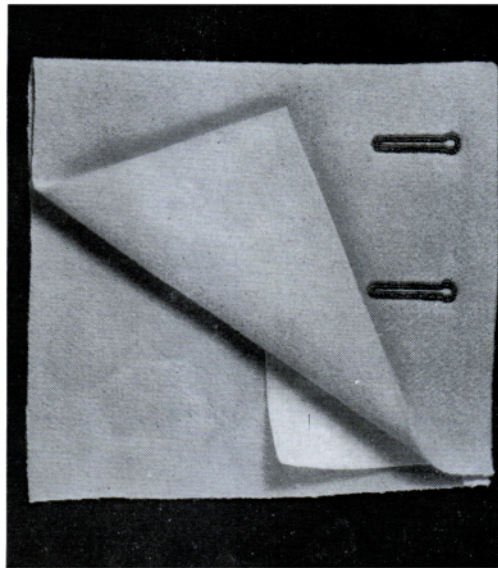

CELLOPHANE FOR MATERIAL PROTECTION

On high pile materials, luster finish, or material with a decided nap, use a piece of cellophane placed over the buttonhole marking before it is placed under the Cloth Clamp. This will ensure a smoother placement under the Cloth Clamp with no danger of teeth catching into threads in weave of material. When garment has been correctly positioned, cellophane can be drawn out before presser bar is lowered. (The removable cellophane usually carried in your card case or purse calendar is ideal for this purpose.) Slide it over the finished buttonhole when removing the garment from under the Cloth Clamp.

Fig. 15

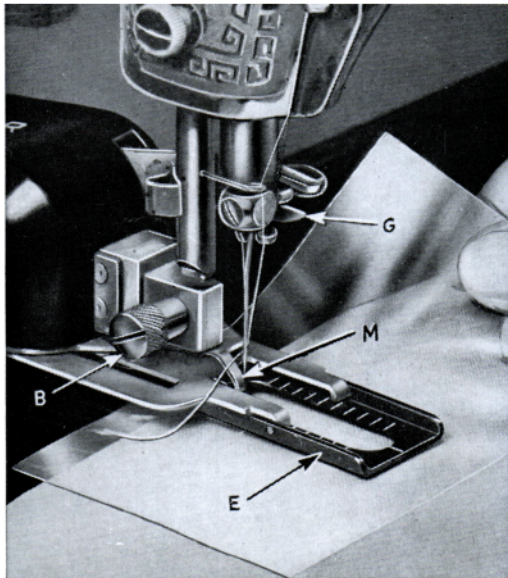

MAKING EXTENDED BUTTONHOLES

To produce a buttonhole longer than 1-1/16" only two steps are required.

Step 1—Stitch a 1 inch buttonhole at outer edge of garment, starting on the left half, leaving forward end open.

Step 2—Add the extra length necessary to get size desired in the finished buttonhole.

Following are detailed instructions for doing this work.

Use the 1-1/16" Template for either keyhole or straight buttonhole.

Baste mark garment for buttonhole placement in the same manner described for producing a buttonhole on (page 14).

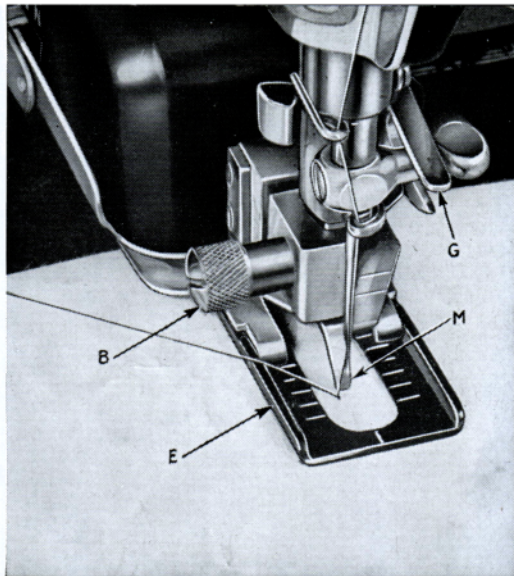
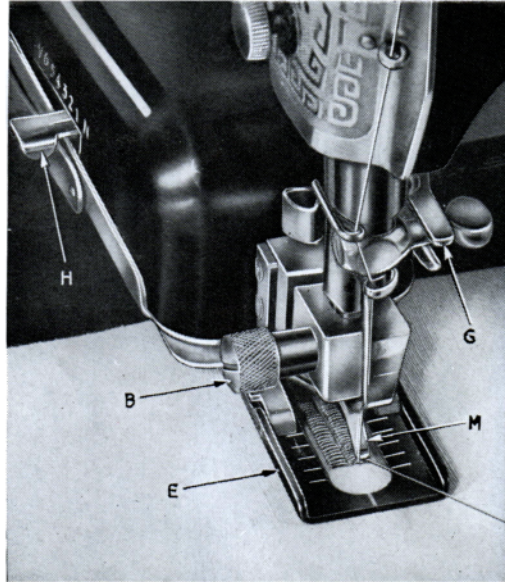

Fig. 16

Turn Adjusting Knob (D, Fig. 10) clockwise until Cloth Clamp (E) is all the way forward toward you. Place material under Cloth Clamp (E) and guide it so that the needle will be directly above marking for outer edge of buttonhole. Lower presser bar. Keep needle out of fabric.

Turn Adjusting Knob (D) clockwise again until needle is opposite second line from front (Fig. 16) on the left side of Cloth Clamp (E). Pick up bobbin thread at this point and start stitching up left half of buttonhole, around end, and down right half stopping at second line from front directly opposite starting point, as shown in (Fig. 17). If extra strength is desired break threads, turn Cloth Clamp to starting position and stitch buttonhole a second time.

Fig. 17



One inch of the buttonhole is now completed with end nearest you open. Leave needle in fabric at this point. Hold fabric firmly on bed of machine with the left hand. Raise Cloth Clamp (E) by raising presser bar with the right hand, being careful that material does not shift. Then move Cloth Clamp by turning Adjusting Knob (D) clockwise moving Cloth Clamp (E) across open forward end, up entire length at left half, across back and down right half stopping at the line that will give extra length required.

Each space between the lines ahead of needle adds $1/8''$ to 1 inch buttonhole already completed. Therefore, if needle is brought opposite fifth line from rear on the right half of Cloth Clamp, a $1-1/2''$ buttonhole will be produced.

Fig. 18

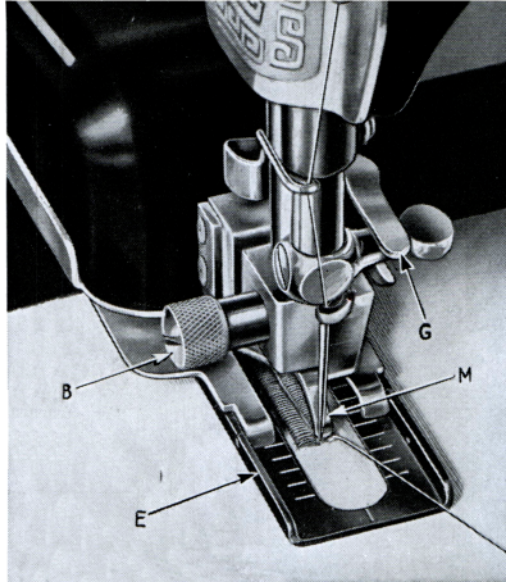

Counting lines from the rear:—

Line 1	produces a	2	inch	buttonhole
" 2	"	" 1-7/8	"	"
" 3	"	" 1-3/4	"	"
" 4	"	" 1-5/8	"	"
" 5	"	" 1-1/2	"	"
" 6	"	" 1-3/8	"	"
" 7	"	" 1-1/4	"	"
" 8	"	" 1-1/8	"	"

Lower Cloth Clamp (E) and continue stitching added length of buttonhole. If extra strength is desired break thread, turn Cloth Clamp to starting position of second half of the buttonhole and stitch a second time.

Fig. 19

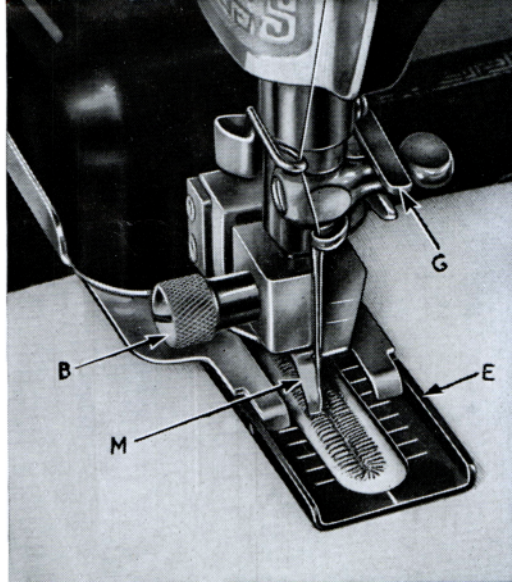

MONOGRAMING AND EMBROIDERY

Monograms made with the Buttonhole Attachment are lovely and can be embroidered in even width tailored stitching, not wider than one-eighth inch, which is the widest stitch on the Buttonhole Attachment, or varied widths are possible if Bight Adjuster (H) is used for tapering the stitch. Use the 1-1/16" straight Template for all embroidery.

Trace design on fabric. Use a filler thread on the line of design so it will be caught with the first stitch. Holding filler thread high will keep stitches uniformly close. The width of embroidery will determine the size filler thread to be used.

Turn Adjusting Knob (D) clockwise until the

Fig. 20

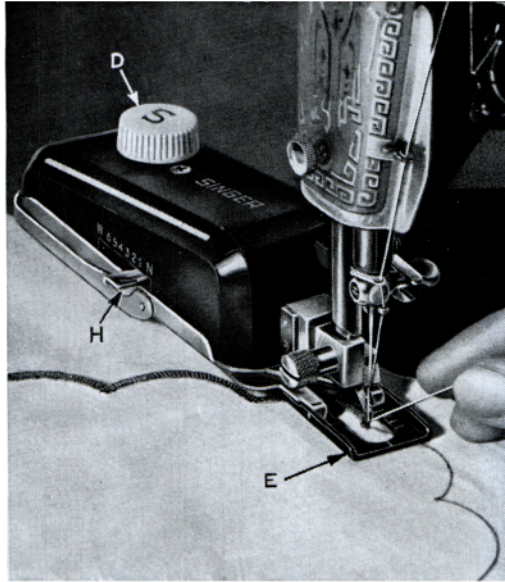

needle is at rear of Cloth Clamp (E), starting down the right half.

When embroidering in uniform stitch, work down the right half allowing stitches to cover filler. Stop with needle on right half of Cloth Clamp opposite second line from front. Lower needle and raise attachment. Turn Adjusting Knob, moving it until needle is again at the upper right half of Cloth Clamp and continue to stitch.

To follow designs where curved lines are used, make only a few stitches at a time. Keep needle in fabric at outside of curve. Raise attachment and turn work to keep stitching on line of design.

A row of stitching with bight set at 1 or 2, covering a fine filler thread, is ideal for edging tapered scallops.

Fig. 21



HELPFUL SUGGESTIONS

- ***Whipstitch Buttonholes***

For whipstitch buttonholes, use ordinary or heavy bobbin thread tension, and lighter top tension to draw lock of stitch to under side of buttonhole. Fine upper thread makes the prettiest whipstitch buttonhole. The bobbin thread need not be fine. Mercerized upper and lower threads give very good results.

- ***Purl Buttonholes***

For purl buttonholes, resembling hand-made buttonholes, have the bobbin thread tension very light and adjust the needle thread tension according to the material being used, so as to draw the lock of the stitch to the top of material. It may not be necessary to alter the adjustment of the bobbin thread tension if fine thread or silk is used on the bobbin.

Either No. 60 mercerized or No. 90 cotton thread, or letter "A" silk should be used on the bobbin for best results, with the same color No. 50 cotton thread or heavy duty mercerized thread in the needle.

Set the attachment for widest bight when high pile or thick bulky materials are being used. When embroidering with Buttonhole Attachment keep bobbin tension tight and upper tension just loose enough to allow thread to cover side travel smoothly.

The SINGER* Seam Ripper will be found ideal for cutting buttonholes. Place buttonhole over heavy cardboard, stretch buttonhole lengthwise. Cut the buttonhole, starting alternately from each end toward the center.

28
PARTS FOR BUTTONHOLER No. 160506

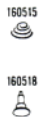
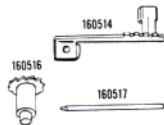
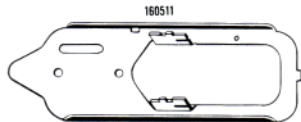

160520



140526



160523



140527



140528



160526



160527



160528



160531

140929



160533

160535

160537

160536

160538



160540



160541

160542

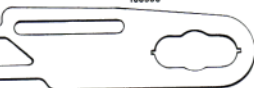

160543

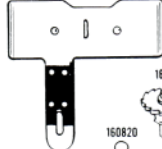

160544



160545

160548

160549

160550

160551

160552

160553

160554

160555

160820



140530



160558

Base	160511	Driving Lever	160527	Retainer Spring	160544
Cover	160512	Lever Stud	160528	Hanger	160818
Slide Washer	160513	Adaptor Rivet	160529	Ratchet Brake Spring	160547
Slide Adjuster	160514	Cam Friction Washer	160816	1-1/16" Straight	
Slide Spring	160515	Friction Spring	160531	Template	160548
Knob Assembly	140525	Stripper Foot Screw	140529	13/16" Template	160549
Cam Shaft Sub. Assy.	160516	Ratchet		5/8" Template	160550
Retainer Hinge	160517	Pawl Rivet	160817	5/16" Template	160551
Slide Stud	160518	Pawl Spring	160533	1-1/16" Keyhole	
Stripper Foot	160519	Pawl	160534	Template	160552
Stripper Spring	160520	Pawl Stud	160535	Cover Bridge	160553
Spring Pawl	160813	Pawl Spring Rivet	160536	Adaptor	160554
Anchor Screw	140526	Cam Support Rivet	160537	Retainer Spring Rivets	160545
Ratchet Brake Roll	160814	Lever Bushing	160538	Cam Support	160555
Fork Arm	160523	Cam Roller Stud	160539	Ratchet and Bushing	
Cover Screw	140527	Cam Roller	51937	Assembly	160819
Cloth Clamp	160524	Pinion	160540	Slotted Clamping	
Cam Set Screw	140528	Pinion Washer	160541	Screw	140530
Cam Assembly	160815	Feed Blade	160542	Retainer Hinge Spring	160558
Retainer Plate	160526	Cover Plate Assy.	160543	Pawl Spring	160820

LUBRICATING THE ATTACHMENT

Occasionally apply a drop of SINGER* Sewing Machine Oil to arrow points marked "N". Apply SINGER* Motor Lubricant to arrow points marked "P". Then wipe dry so that work will not be stained.

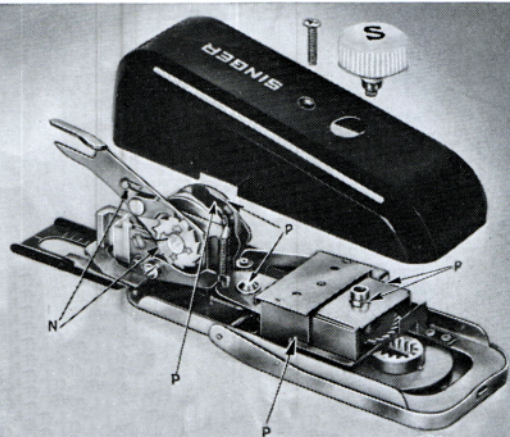
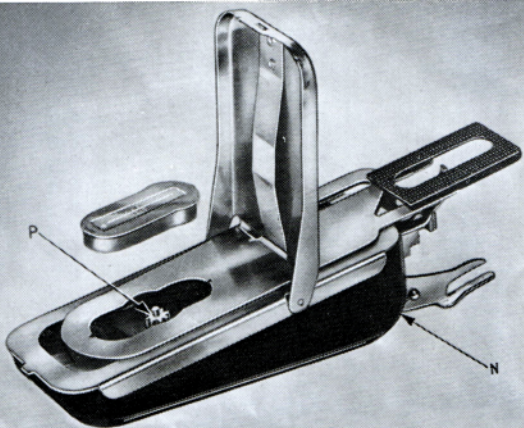

The SINGER Buttonholer is only one of many attachments available at your SINGER SEWING CENTER . . . attachments which will enable you to produce all kinds of decorative effects and finishes with a minimum of time and effort . . . attachments which can give your home sewing that smart professional look.

YOUR SINGER SEWING CENTER stands ready to help you with instructions and advice on Home Dressmaking and Home Decorations. You'll also find a hundred and one other helpful sewing services and supplies. Our finishing services include Hemstitching, Custom Made Belts, Button and Buckle Covering, Picoting. Here too you will also find the widest selection of thread, zippers, buttons and other notions.

Drop in and get acquainted at your

SINGER SEWING CENTER

